

Assembly, installation and maintenance manual

Montage-, Aufbau- und Wartungsanleitung • Assemblage, manuel de montage et d'entretien • Montaje, instalación y mantenimiento • Manuale di montaggio, installazione e manutenzione • Monterings- og vedlikeholdsmanual • Monterings-, installations- och underhållsmanual • Kokoamis-, asennus- ja huolto-ohje • Vejledning for montering og vedligehold • Handleiding voor montage, installatie en onderhoud • Manual de montagem, instalação e manutenção • Návod k montáži, instalaci a údržbě • Instrukcja montażu, instalacji i konserwacji • Surinkimo, montavimo ir priežiūros vadovas • Montāžas, uzstādīšanas un apkopes rokasgrāmata • Руководство по сборке и обслуживанию • Montaaži-, paigaldus- ja säilitamise juhend



Glasshouse **PA44-4254**

Treatment options, Item code

• Behandlungsoptionen, Artikel-Code • Traitement options, code de l'article • Opciones de tratamiento, código del artículo • Opzioni di trattamento, codice articolo • Behandlingsalternativer, artikkelnummer • Behandlingsalternativ, varukod • Käsittelevaihtoehdot, yksikön koodi • Behandlingsmuligheder, artikel nummer • Behandlingsopties, artikelnummer • Opções de tratamento, código do artigo • Povrchové úpravy, kód položky • Możliwości leczenia, kod produktu • Apdorojimo variantai, prekės kodas • Apstrādes iespējas, artikula kods • Варианты обработки, код изделия • Tõõtlusvõimalused, tootekood

GYVPI 109878

<p>Factory inspection by • Werkskontrolle durch • Contrôle à partir de l'usine par • Inspector de fábrica • Collaudato da • Fabrikkkontroll utført av • Fabriksbesiktigat av • Tehtaan tarkastaja • Fabriks Kontrol udført af • Fabrikscontrole door • Inspeção de fábrica, por: • Zkontrolováno ve výrobním závodě • Kontrola fabryczna do • Apžiūrą gamykloje atliko • Rūpnīcas pārbaudi veicis • Заводской контроль • Tehase kontroll teostatud:</p> <p>.....</p>	<p>Date • Datum • Date • Fecha • Data • Dato • Datum • Päiväys • Dato • Datum • Data • Datum • Data • Datums • Data • Дата • Kuupäev:</p> <hr/> <p>Pack number • Pack Nr. • Packet n° • Bulto N° • Pacco N. • Serienr • Produktionsnummer • Pakettinro • Pakke nr. • Pak nr. • Número de embalagem • Číslo balení • Numer opakowania • Pakuotės numeris • Iepakojuma numurs • Упаковочный номер • Pakinumber:</p>
-----------------------------------------------------------------------------------------------------------------------------------------------------------------------------------------------------------------------------------------------------------------------------------------------------------------------------------------------------------------------------------------------------------------------------------------------------------------------------	---------------------------------------------------------------------------------------------------------------------------------------------------------------------------------------------------------------------------------------------------------------------------------------------------------------------------------------------------------------------------------------------------------------------------------

Inspection Certificate

Kontrollschein • Bulletin de contrôle • Certificado de control • Certificato di controllo • Kontrollskjema • Besiktningsprotokoll • Tarkastustodistus • Kontrol Certifikat • Control Certificaat • Certificado de Inspeção • Kontrolní certifikát • Certyfikat kontrolny • Apžiūros pažyma • Pārbaudes akts • Акт осмотра • Kontrollakt

Art. Nr. PA44-4254

Please keep safely!

Bitte gut aufbewahren! • A bien conserver, s.v.p.! • ¡A conservar! • Da conservare! • Ta vare på denne! • Vänligen förvara säkert! • Ole hyvä ja säilytä huolella! • Opbevares sikkert! • Zorgvuldig te bewaren! • Por favor, guarde em segurança! • Prosím, pečlivě uschovejte! • Przechowywać w bezpiecznym miejscu! • Laikykite saugiai! • Lūdzu, glabājiet drošā vietā! • Хранить в надежном месте! • Palun säilitada hoolsalt!

English: The product you have purchased was manufactured in accordance with the high quality norms. The product unit has been carefully inspected and packed. In order to avoid possible problems during the assembly carried out by yourself or the building company of your choice, we recommend that you inspect the delivery for its completeness in accordance with the list of pieces before assembly. This inspection must be carried out within 14 days after delivery to your place. Warranty claims are limited to the exchange of defective materials. Defective product parts, which have already been used or painted, are excluded from being replaced. All further claims are excluded! In cases of complaints, please pay attention to the following procedures: Please present this inspection certificate along with the sales receipt to your place of purchase. Only in cases where these documents are presented will the complaint be dealt with quickly and without complications.

Deutsch: Der von Ihnen gekaufte Artikel wurde nach der hohen Qualitätsnorm gefertigt. Der Bausatz wurde sorgfältig geprüft und verpackt. Um etwaige auftretende Probleme während des Aufbaus durch Sie oder Ihre Aufbaufirma zu vermeiden, kontrollieren Sie bitte die Lieferung auf Vollständigkeit laut Stückliste vor dem Aufbau. Diese Kontrolle muss innerhalb 14 Tagen nach Anlieferung bei Ihnen erfolgen. Ansprüche auf Gewährleistung beschränken sich auf den Austausch von fehlerhaftem Material. Fehlerhafte Bauteile, die bereits verbaut oder gestrichen wurden, sind vom Umtausch ausgeschlossen. Alle weiteren Ansprüche sind ausgeschlossen! Sollte es zu einer Beanstandung kommen, beachten Sie folgende Vorgehensweise: Legen Sie Ihrem Fachhändler diesen Kontrollschein zusammen mit dem Einkaufsbeleg vor. Nur bei Vorlage dieser Unterlagen ist eine schnelle und problemlose Bearbeitung Ihrer Beanstandung möglich.

Français: Le produit que vous venez d'acheter a été fabriqué en respectant de hautes normes de qualité. Ce produit a été testé et emballé avec soin. Afin d'éviter des problèmes éventuels pendant la construction par vous-même ou par la société de construction mandatée, nous vous prions de bien vouloir vérifier que toutes les pièces ont été fournies selon la liste des pièces avant que vous ne commenciez la construction. Il vous incombe de faire ce contrôle dans les 14 jours après la fourniture. Les revendications en dédommagement se limitent à l'échange de matériel défectueux. Les pièces défectueuses, déjà construites ou peintes, ne font pas l'objet de l'échange. Toutes les revendications ultérieures ne sont pas prises en compte ! En cas d'une réclamation, veuillez respecter le déroulement suivant : il vous faudra présenter à votre commerçant agréé ce bulletin de contrôle avec le récépissé de l'achat. Ce ne sera que moyennant présentation de ces documents qu'un traitement rapide et sans problème de votre réclamation sera possible!

Español: El producto que ha adquirido ha sido fabricada de acuerdo con normas de alta calidad. Las piezas del producto han sido cuidadosamente inspeccionadas y embaladas. Con el fin de evitar posibles problemas durante el montaje, hecho por usted o por la empresa de construcción de su elección, le recomendamos revisar el paquete entregado, con la lista de piezas, antes de armar el producto. Haga la revisión dentro de 14 días después de recibir el paquete. La garantía se limita a reemplazar las piezas defectuosas. No se reemplazarán las partes defectuosas que ya hayan sido utilizadas o pintadas. ¡No se aceptan otras reclamaciones! En casos de queja, por favor, presente este certificado junto con la factura en el lugar donde hizo la compra. Sólo presentando estos documentos podremos resolver su problema rápidamente y sin complicaciones.

Italiano: Il prodotto che avete acquistato è stata prodotta secondo la norma di alta qualità. Il kit è stato controllato ed imballato con cura. Per evitare eventuali inconvenienti durante il montaggio, si prega di verificare, prima del montaggio, la completezza della fornitura in base alla distinta dei pezzi. Tale verifica deve essere effettuata entro 14 giorni dalla consegna. Eventuali diritti di garanzia si limitano alla sostituzione di materiale difettoso. Gli elementi difettosi già montati o verniciati sono esclusi dal diritto alla sostituzione. Ogni altro diritto resta escluso! In caso di reclamazione, procedere nel modo seguente: presentare questo certificato di controllo unitamente alla prova d'acquisto al rivenditore. Solo in questo modo la Sua reclamazione potrà essere evasa rapidamente e senza problemi.

Norsk: Produktet du har kjøpt, ble produsert i henhold til høye kvalitetskrav. Produktet har blitt kontrollert nøye og deretter omhyggelig pakket. For å unngå mulige problemer under monteringen, uansett om du gjør det selv eller får en godkjent håndverker til å gjøre det, anbefaler vi at du kontrollerer leveransen mot delelisten for å se om alle delene er inkludert. Denne kontrollen må gjøres innen 14 dager etter at delene ble levert til din adresse. Garantikrav begrenser seg til bytte av defekte deler. Defekte elementer som allerede har blitt brukt eller malt/beiset/limt, vil ikke bli erstattet. Alle andre krav er utelukket! Dersom du har en reklamasjon, vennligst gjør som følger: Lever dette kontrollskjema med kvitteringen til salgsstedet. Bare når du har med disse dokumentene kan klagen behandles raskt og uten komplikasjoner.

Svenska: Produkten du köpt har tillverkats i enlighet med de högsta kvalitetsstandarderna. Produktens delar har noggrant besiktigats och förpackats. För att undvika eventuella problem under monteringen som du utför själv eller låter en hantverkare att utföra, rekommenderar vi att du, innan monteringen påbörjas, besiktigar leveransen för att säkerställa att den är komplett enligt förteckningen över ingående delar. Denna besiktning måste utföras inom 14 dagar efter att du tagit emot leveransen. Garantianspråk är begränsade till ersättning av defekt material. Defekta produkt delar, vilka redan har använts eller målats, ersätts inte. Alla vidare anspråk avvisas! I händelse av reklamationer, vänligen uppmärksamma följande: uppvisa detta besiktningsprotokoll tillsammans med inköpsbeviset till ditt inköpsställe. Endast om dessa dokument uppvisas kan vi garantera att reklamationen behandlas skyndsamt och utan krångel.

Suomi: Ostamasi tuote on valmistettu korkeita laatuvaatimuksia noudattaen, huolella tarkastettu ja pakattu. Jotta pystytys joko itsesi tai valitsemasi rakennusliikkeen toimesta sujuisi ongelmitta, suosittelimme, että tarkistat toimituksen sisällön osaluettelon avulla ennen kokoamisen aloittamista. Tämä tarkistus tulee tehdä 14 päivän kuluessa toimituksesta. Takuuvaateet rajoittuvat viallisten materiaalien vaihtamiseen. Viallisia osia, joita on jo käytetty ja jotka on maalattu, ei vaihdeta uusiin. Lisävaatimuksia ei huomioida! Mahdollisissa valitustapauksissa toimi seuraavasti: Esitä oheinen tarkastustodistus ja kassakuitti ostopaikassa. Valituksen nopea ja mutkaton käsittely edellyttää näiden asiakirjojen esittämistä.

<p>Dansk: Det købte produkt fremstillet i overensstemmelse med de høje kvalitetskrav. Produktet er blevet omhyggeligt inspiceret og pakket. For at undgå eventuelle problemer i løbet af monteringen udført af dig selv eller håndværker af dit eget valg, anbefaler vi, at du undersøger leverancen for fuldstændighed i overensstemmelse med listen over dele før samling. Denne inspektion skal foretages inden 14 dage efter levering til din plads. Garantikrav er begrænset til udveksling af defekte materialer. Defekte produkter, som allerede er brugt eller malet, er udelukket fra at blive erstattet. Alle yderligere krav er udelukket! I tilfælde af klager, skal du være opmærksom på følgende procedurer: Venligst præsenterer denne kontrolcertifikat sammen med kvitteringen til det sted hvor produktet er købt. Kun i de tilfælde, hvor disse dokumenter er forelagt kan klagen behandles hurtigt og uden komplikationer.</p>
<p>Dutch: Het door U gekochte product werd vervaardigd overeenkomstig hoge kwaliteitsnormen. Het product werd zorgvuldig gecontroleerd en verpakt. Om tijdens de montage, uitgevoerd door Uzelf of een door U gekozen aannemer, problemen te vermijden, raden we U aan, vóór de montage de levering te controleren op volledigheid in overeenstemming met de onderdelenlijst. Deze controle dient te gebeuren binnen 14 dagen na levering bij U thuis. Garantieclaims zijn beperkt tot het vervangen van defecte onderdelen. Defecte onderdelen die al gebruikt of geschilderd zijn, zijn uitgesloten van vervanging. Alle latere claims zijn uitgesloten! In geval van klachten dient u als volgt te handelen: Toon dit controlecertificaat, samen met Uw aankoopbewijs aan Uw verkoper. Alleen wanneer deze documenten getoond worden, zal de klacht snel en zonder complicaties in behandeling worden genomen.</p>
<p>Português: O produto que comprou foi fabricado em conformidade com as normas de alta qualidade. A unidade do produto foi cuidadosamente inspecionada e embalada. Para evitar possíveis problemas durante a montagem realizada por si ou pela empresa de construção à sua escolha, recomendamos que inspecione a entrega na íntegra, em conformidade com a lista de peças antes da montagem. Esta inspeção deve ser realizada no prazo de 14 dias após a entrega. As reclamações de garantia limitam-se à troca de materiais defeituosos. As peças do produto com defeito, que já tenham sido utilizadas ou pintadas, excluem-se da substituição. Excluem-se todas as outras reclamações! Em caso de reclamações, por favor, tome atenção aos seguintes procedimentos: Por favor, apresente este certificado de inspeção, juntamente com o recibo de venda no seu local de compra. Apenas nos casos em que estes documentos sejam apresentados a queixa será tratada com rapidez e sem complicações.</p>
<p>Čeština: Produkt, který jste zakoupil, byl vyroben v souladu s normami stanovujícími vysokou kvalitu. Produkt byl výrobcem pečlivě prohlédnutý a zabaleny. Aby se předešlo možným problémům při montáži prováděné svépomocí nebo stavební firmou dle vašeho výběru, doporučujeme vám před montáží zkontrolovat dodávku na úplnost v souladu se seznamem dílů. Tato prohlídka musí být provedena do 14 dnů (!) od doručení do místa určení. Záruční nároky jsou omezeny na výměnu vadných materiálů. Vadné produkty, které již byly použity nebo které jsou již opatřeny nátěrem, nemohou být nahrazeny. Všechny další nároky jsou vyloučeny! V případě reklamace věnujte prosím pozornost tomuto postupu: Předložte svému prodejci tento kontrolní certifikát spolu s prodejním dokladem. Pouze v případě, kdy jsou předloženy oba tyto dokumenty, lze reklamaci řešit rychle a bez komplikací.</p>
<p>Polski: Produkt, który Państwo zakupili, wykonano według najwyższych norm jakości. Elementy konstrukcyjne przed zapakowaniem przeszły dokładną kontrolę jakości. Aby uniknąć problemów podczas samodzielnego montażu, bądź montażu zleconego firmie budowlanej, przed montażem zalecamy sprawdzenie zawartości przesyłki zgodnie z listą części zamieszczonych w zestawie. Kontrola kompletności zestawu należy dokonać w ciągu 14 dni od dostarczenia przesyłki. Reklamacje objęte gwarancją ograniczają się do wymiany wadliwych elementów. Wadliwe elementy, które zostały użyte lub pomalowane nie będą podlegały wymianie ani dalszym reklamacjom. W przypadku potrzeby zgłoszenia reklamacji, prosimy przestrzegać poniższych procedur: prosimy przedłożyć Certyfikat kontrolny wraz z paragonem zakupu i adresem dostawy. Reklamacje będą rozpatrywane wyłącznie po dostarczeniu powyższych dokumentów.</p>
<p>Lietuviškai: Produktas, kurį įsigijote, pagamintas pagal aukštos kokybės standartus. Produkto blokas, kurį reikia surinkti, buvo atidžiai patikrintas ir supakuotas. Siekiant išvengti galimų problemų surenkant produktą patiems arba pasirinkus tam norimą statybos bendrovę, prieš surenkant rekomenduojame patikrinti pristatymo komplektaciją pagal dalių sąrašą. Ši patikra turi būti atlikta per 14 dienų nuo pristatymo į jūsų namus vietą. Garantinės sąlygos taikomos tik brokuotoms dalims. Brokuotos produkto dalys, kurios buvo panaudotos arba nudažytos, nebekeičiamos. Visos kitos pretenzijos nesvarstomos! Jei teikiate pretenziją, atkreipkite dėmesį į šias procedūras: į produkto įsigijimo vietą turite pristatyti apžiūros pažymėjimą bei pirkimo kvitą. Tik tais atvejais, kai pristatomi minėti dokumentai, pretenzija gali būti nagrinėjama greitai ir be komplikacijų.</p>
<p>Latviešu: Produkts, kuru esat iegādājies, ir ražota saskaņā ar augstām kvalitātes normām. Šī produkta vienība ir rūpīgi pārbaudīta un iepakota. Lai izvairītos no iespējamiem sarežģījumiem montāžas laikā, kuru veicat jūs pats vai jūsu izvēlēts celtniecības uzņēmums, pirms montāžas iesakām pārbaudīt, vai piegādātajam izstrādājumam nekas netrūkst, izmantojot detaļu sarakstu. Šī pārbaude jāveic 14 dienu laikā pēc piegādāšanas. Garantija paredz tikai defektīvo materiālu apmaiņu. Defektīvas produkta detaļas, kuras jau ir izmantotas vai nokrāsotas, netiks mainītas. Visas turpmākās pretenzijas tiks noraidītas! Sūdzību gadījumā, lūdzu, ievērojiet šādu kārtību: lūdzu, uzrādiet šo pārbaudes aktu kopā ar pirkuma čeku izstrādājuma iegādāšanās vietā. Sūdzība tiks atrisināta ātri un bez sarežģījumiem tikai tad, ja tiks uzrādīti šie dokumenti.</p>
<p>Русский: Приобретенное вами изделие изготовлено по высоким стандартам качества. Изделие внимательно проверено и упаковано. Во избежание возможных проблем в процессе сборки, выполняемой самостоятельно или привлеченной вами строительной компанией, рекомендуем перед сборкой проверить комплектность поставки по комплектвочной ведомости. Такую проверку следует провести в течение 14 дней после доставки товара. Претензии по гарантии ограничиваются заменой дефектных материалов. Дефектные части изделия, которые уже были использованы или окрашены, замене не подлежат. Все прочие претензии не принимаются! Порядок подачи претензии: Претензия подается с настоящим актом осмотра и товарным чеком по месту покупки товара. Только при наличии всех указанных документов претензия будет рассмотрена быстро и без сложностей.</p>
<p>Eesti: Ostetud toode on toodetud vastavuses kõrgete kvaliteedi normidega. Toote ühik on hoolikalt kontrollitud ja pakendatud. Et vältida võimalikke probleeme paigaldamisel, mida teostate ise või teostab teie poolt valitud paigaldusettevõte, soovime enne paigaldama asumist kontrollida toote komplekssust detailide nimekirja alusel, mille leiate kaasas olevast juhendist. See kontroll tuleb teostada 14 päeva jooksul pärast tarnet. Garantii alla kuuluvad kaebused on piiratud defektsete detailide välja vahetamisega. Defektsed detailid, mida on juba kasutatud või värvitud, ei kuulu garantiikorras välja vahetamisele. Kõik edasised kaebused on välistatud! Kaebuste korral palun pöörake tähelepanu järgnevale: palun hoidke see kontrollakt koos müügiarvega alles. Ainult nende dokumentide esitamisel lahendatakse kaebused kiiresti ja ilma komplikatsioonideta.</p>

The producer shall have the right to make technical changes to the product. • Technische Änderungen vorbehalten. • Le producteur réserve le droit d'effectuer des modifications techniques au produit. • Reservado el derecho a modificaciones técnicas. • Il produttore mantiene il diritto di apportare modifiche tecniche al prodotto. • Producent forbeholder seg retten til å endre tekniske egenskaper ved produktet. • Tillverkaren har rätt att utföra tekniska förändringar för produkten. • Valmistaja pidättää oikeuden tehdä tuoteeseen teknisiä muutoksia. • Producenten har ret til at foretage tekniske ændringer ved produktet. • Alle rechten en technische wijzigingen voorbehouden. • O fabricante reserva-se o direito de realizar alterações técnicas ao produto. • Výrobce je oprávněn provádět technické úpravy produktu. • Producent zastrzega sobie prawo do dokonywania zmian technicznych produktu. • Gamintojas turi teisę atlikti techninius gaminio pakeitimus. • Ražotājs patur tiesības veikt tehniskas produkta izmaiņas. • Производитель оставляет за собой право вносить в изделие технические изменения. • Tootja jätab endale õiguse muuta toote tehnilisi omadusi.

To be completed by buyer! (Please use block letters) • Vom Käufer auszufüllen! (Bitte in Druckschrift) • A remplir par l'acheteur! (en lettres d'imprimerie, s'il vous plaît) • ¡Completa el cliente! (en mayúsculas) • Da compilare dall'acquirente! (in stampatello) • Fylles ut av kjøper! (Vær vennlig å bruke blokkbokstaver) • Fylls i av köparen! (Vänligen texta) • Ostaja täyttää! (Ole hyvä ja käytä isoja kirjaimia) • Udfyldes af køber! (Benyt venligst Blokbogstaver) • In te vullen door de koper! (Graag in drukletters) • A completar pelo comprador! (por favor escreva em letra de máquina) • Vyplní kupující! (Prosíme hůlkovým písmem) • Wypełnia nabywca (drukowanymi literami) • Pildo pirkėjas (didžiosiomis raidėmis)! • Aizpilda pircējs! (Lūdzu, izmantojiet drukātos burtus.) • Заполняется покупателем! (печатными буквами) • Täidetakse ostja pool! (palun täita trükitähedede):

Place of purchase • Bezugsquelle • Source d'achat • Lugar de compra • Acquistato presso • Salgs sted • Inköpsställe • Ostopaikka • Salgssted • Plaats van aankoop • Local de compra • Místo nákupu • Miejsce zakupu • Įsigijimo data • Iegādāšanās vieta • Место покупки товара • Ostukoht:

Sales receipt No. • Kaufbeleg-Nr. • Récépissé n° • Recibo N° • Prova d'acquisto N. • Kvitteeringsnr • Försäljningskvittots nummer • Kassakuitin numero • Kasse Bon nr • Aankoopbewijs Nr. • Recibo de venda n.º • Prodejní doklad č. • Nr paragonu • Pardavimo kvito Nr. • Pirkuma čeka Nr. • Номер товарного чека • Müügiarve number:

Sales receipt date • Kaufbeleg-Datum • Date du récépissé • Fecha recibo • Data prova d'acquisto • Kvitteeringsdato • Försäljningskvittots datum • Kassakuitin päiväys • Kasse bons dato • Aankoopbewijs -Datum • Data do recibo de venda • Datum prodejního dokladu • Data paragonu • Pirkimo kvito data • Pirkuma čeka datums • Дата товарного чека • Müügiarve kuupäev:

Delivery date • Lieferdatum • Date de livraison • Fecha de Entrega • Data di consegna • Leveringsdato • Leveransdatum • Toimituspäivä • Leverings dato • Leveringsdatum • Data de entrega • Termín dodání • Data dostawy • Pristatymo data • Piegādes datums • Дата доставки • Tame kuupäev:











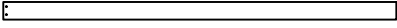



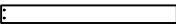

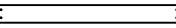









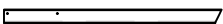



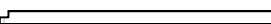

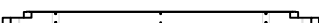







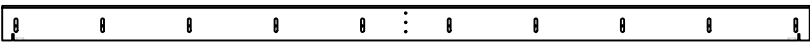

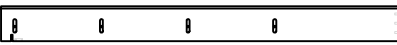

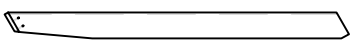

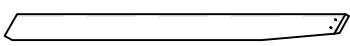

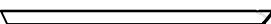

Buyer's address • Kundenanschrift • Adresse du client • Dirección del cliente • Indirizzo del cliente • Kjøpers adresse • Köparens adress • Ostajan osoite • Købers adresse • Adres koper • Morada do comprador • Adresa kupujícího • Adres nabywcy • Pirkėjo adresas • Pircēja adrese • Адрес покупателя • Ostja address:

Telephone • Telefon • Téléphone • Teléfono • Telefono • Telefon nr • Telefon • Puhelin • Telefon • Telefoon • Telefone • Telefon • Telefon • Telefonas • Tālrunis • Телефон • Telefon:









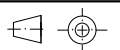





























Forwarder: Pick-up Others •
 Afhalen: Spedition Selbstabholer •
 Par: Transporteur Propres moyens •
 Entrega: Transporte organizado Transporte propio •
 Tramite: Spedizioniere Mezzo proprio •
 Transportør: Sendes Hentes •
 Speditör: Avhämtning Övrigt •
 Rahdinkuljettaja: Nouto Muut •
 Transportør: Sendes Hentes •
 Door: Verzending Zelf •
 Remetente: Entrega Outros •
 Zasilatel: Sběrná služba Ostatní •
 Przekazywanie: Odbiór w sklepie Inne •
 Ekspeditorius: "Pick-up" Kita •
 Ekspeditoris: Saņemšana uz vietas Cits •
 Экспедитор: Приемка Прочее •
 Transport: Järgi tulemine Muu





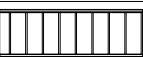

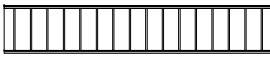
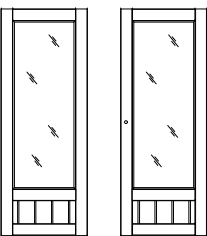

Description of complaint • Schilderung der Beanstandung • Déscription de la réclamation • Descripción del problema • Descrizione della reclamazione • Beskrivelse av feil/ mangel • Beskrivning av reklamationen • Valituksen kuvaus • Beskrivelse af fejl / Mangel • Beschrijving van de klacht • Descrição da reclamação • Popis reklamace • Opis reklamacji • Skundo aprašymas • Sūdzības apraksts • Содержание претензии • Kaebuse kirjeldus

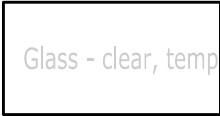





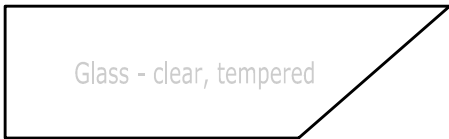
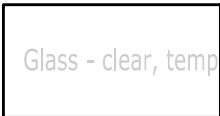







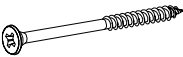
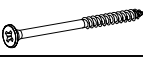







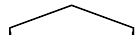
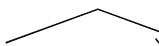

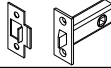
Please keep the parts which are the object of the complaint until the complaint is settled! • Bitte bewahren Sie unbedingt alle die Reklamation betreffenden Bauteile/Gegenstände auf, bis die Bearbeitung abgeschlossen ist. • Veuillez garder les pièces contestées jusqu'à ce que la réclamation soit traitée définitivement! • Por favor, conserve las piezas objeto de la queja hasta que el problema haya sido resuelto • Si prega di conservare i pezzi reclamati fino all'evasione della reclamazione! • Vær vennlig å ta vare på de aktuelle delene/ produktet inntil saken er avsluttet! • Vänligen behåll delarna som är föremål för reklamation tills reklamationen har behandlats! • Ole hyvä ja säilytä osat, joita valitus koskee, kunnes valitus on käsitelty! • Venligst ta hånd om de aktuelle dele / produkt indtil sagen er afsluttet! • Gelieve de betrokken onderdelen te bewaren tot de klacht is afgehandeld • Por favor, guarde as peças objeto da reclamação, até que a reclamação esteja resolvida! • Uchovajte prosím díly, které jsou předmětem stížnosti, dokud reklamace nebude vyřízena! • Prosimy zachować części będące przedmiotem reklamacji do czasu jej rozpatrzenia. • Dalis, kurios yra skundo objektas, reikia išsaugoti tol, kol skundas bus išnagrinėtas! • Lūdzu, saglabājiet detaļas, uz kurām sūdzība attiecas, līdz sūdzība tiek atrisināta! • Просим сохранить части, являющиеся предметом претензии, до ее разрешения! • Palun hoidke kaebust puudutavad objektid/detailid alles, kuni kaebus on lahendatud!

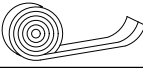
Pos	SPECIFICATION-STÜCKLISTE-NOMENCLATURE-ELEMENTI	Pcs	Profile (mm)	Length (mm)
Emilia T-shape				
1	Foundation beam 	2	 45 × 120	2713
2	Foundation beam 	3	 45 × 120	2910
3	Foundation beam 	2	 45 × 120	1213
4	Foundation beam 	2	 45 × 120	1258
42	Foundation beam 	1	 45 × 120	540
5	Post 	1	 120 × 120	1647
6	Post 	1	 120 × 120	1647
7	Corner Left 	3	 44 × 95	1502
8	Corner Right 	3	 44 × 95	1502
9	Frame 	3	 44 × 95	1893
10	Frame 	3	 44 × 95	1893
11	Frame 	3	 44 × 95	2182
12	Ridge support 	3	 44 × 91	661
13	Rafter Left 	3	 44 × 95	1879
14	Rafter Right 	3	 44 × 95	1879
15	Ridge LONG 	1	 80 × 240	5574
16	Ridge SHORT 	1	 80 × 240	2747
17	Valley rafter 	1	 56 × 180	2376
18	Valley rafter 	1	 56 × 180	2376
19	Frame Side 	12	 44 × 95	1562
20	Rafter 	12	 44 × 95	1879
21	Valley jack 	2	 44 × 95	1877
22	Valley jack 	2	 44 × 95	1877
23	Valley jack 	2	 44 × 95	1155
24	Valley jack 	2	 44 × 95	1155

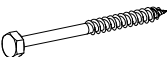

Pos	SPECIFICATION-STÜCKLISTE-NOMENCLATURE-ELEMENTI Emilia T-shape	Pcs	Profile (mm)	Length (mm)
25	Frame 	4	 45 x 45	554
26	Corner 	34	 15 x 173	360
27	Rafter connection 	1	 45 x 12	3035
28	Rafter connection 	6	 45 x 12	1236
29	Slat - side 	18	 45 x 12	1502
30	Slat - roof 	18	 45 x 12	1910
31	Slat - roof 	2	 45 x 12	1829
32	Slat - roof 	2	 45 x 12	1829
33	Slat - roof 	2	 45 x 12	1059
34	Slat - roof 	2	 45 x 12	1059
35	Slat - side 	3	 45 x 12	1894
36	Slat - side 	3	 45 x 12	1818
37	Slat - side 	12	 45 x 12	1827
38	Slat - side 	6	 45 x 12	1383
39	Slat - side 	6	 45 x 12	1814
40	Slat - side 	6	 45 x 12	1478
41	Slat - side 	2	 44 x 12	1502
EL1		657 x 390 x 45		6
EL2		1144 x 390 x 45		2
EL3		1144 x 390 x 45		2
EL4		2968 x 390 x 45		1
EL5		2392 x 390 x 45		1
KUL-145 KUL-145-2		693 x 1818 x 40		3+3
	Object name Emilia T-shape	Page 2 / 4		

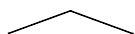
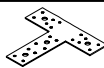
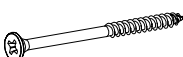
Pos.	Description	Measures (mm)	Pcs
401	 Glass - clear, tempered	578 x 1895 x 4	11
402	 Glass - clear, tempered	578 x 1115 x 4	13
403	 Glass - clear, tempered	578 x 1030 x 4	2
404	 Glass - clear, tempered	620 x 910 x 4	4
405	 Glass - clear, tempered	578 x 1895 x 4	4
406	 Glass - clear, tempered	578 x 979 x 4	2
407	 Glass - clear, tempered	700 x 1862 x 4	3
408	 Glass - clear, tempered	835 x 1074 x 4	4
409	 Glass - clear, tempered	578 x 1844 x 4	2
411	 Glass - clear, tempered	570 x 1115 x 4	4
412	 Glass - clear, tempered	680 x 1458 x 4	6

Pos.	Description	Measures (mm)	Pcs
F1		Thermovent 7kg	4
F2		55 x 60	8
F3		62 x 40 x 13	18
F4	 QHP15x57Zn	15 x 57	12
F5	 QKRPP6x120RVTX	Ø 6 X 120	24
F6	 QKRPP5x90RVTX	Ø 5 X 90	160
F7	 QKRYP5x55RVTX	Ø 5 X 55	440
F8	 QKRYP4_2x38RVTX	Ø 4.2 X 38	420
F9	 QKRPP3_5x40RVTX	Ø 3.5 X 40	36
F10	 QKRPP4x25RVTX	Ø 4 X 25	52
F11	 Polt M6	Ø 6 X 200	12
F12	 QMUUK6Zn	M6	14
F13	 QSE6x18Zn	Ø 6 X 18	28
F14		2750x 120 x 30	3
F15		120 x 150 x 31	1
F16	 QHA150Zn	150 mm	6
F17	 QUNAL		3 set
F18	 QRUAU		3 set
F19	 QLIKA		3 set
F20	 QTIB	0.8 m	1
F21	 QR35100Zn	35 x 100	6
F22	 QKRYP3x16Zn	Ø 3 X 16	48
F23	 Polt M6	Ø 6 X 160	2
F24	 QKRKK12x200Zn	Ø 12 X 200	5
F25	 QSE12x24Zn	Ø 12 X 24	5
F26		2430 x 90 x 23 mm	2
F28	 QNP150x100x40Zn	150 x 100 x 40	1
F29	 QKRPP6x180ZnTX	Ø 6 X 180	8
F30	 QKRPP2_5x16kZn	Ø 2,5 X 16	8

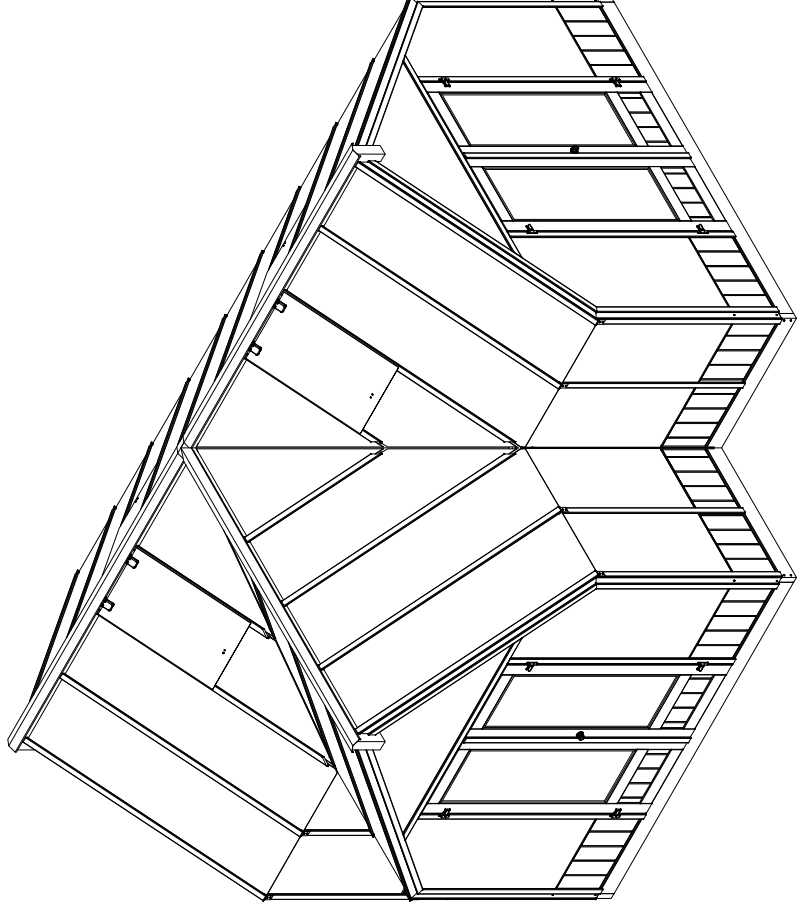
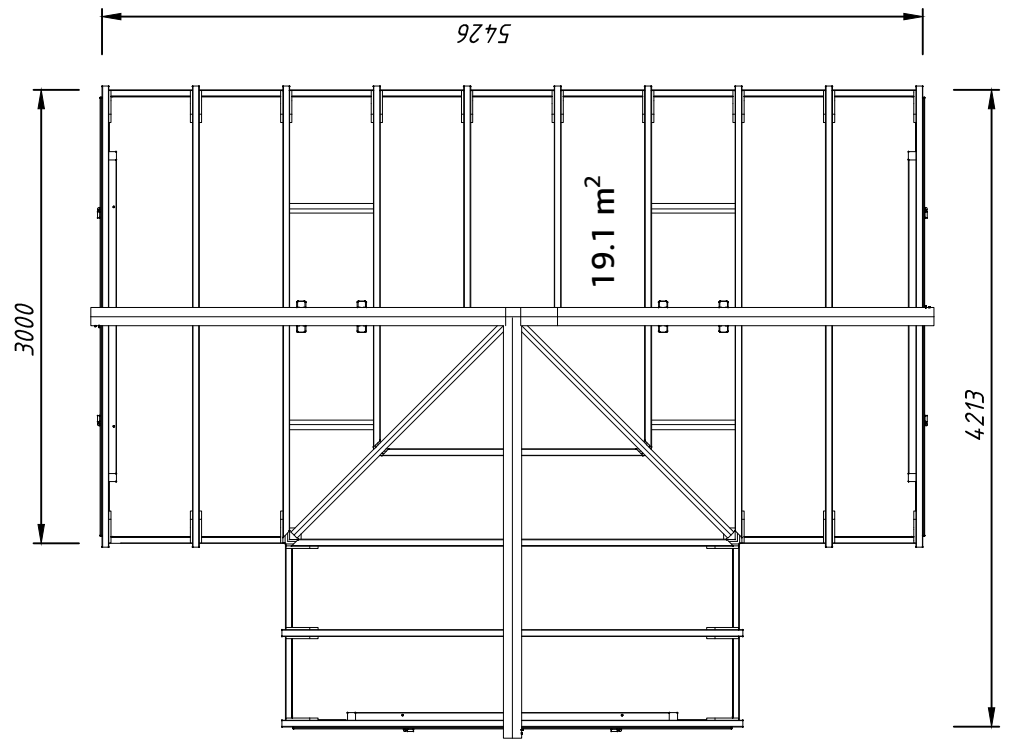
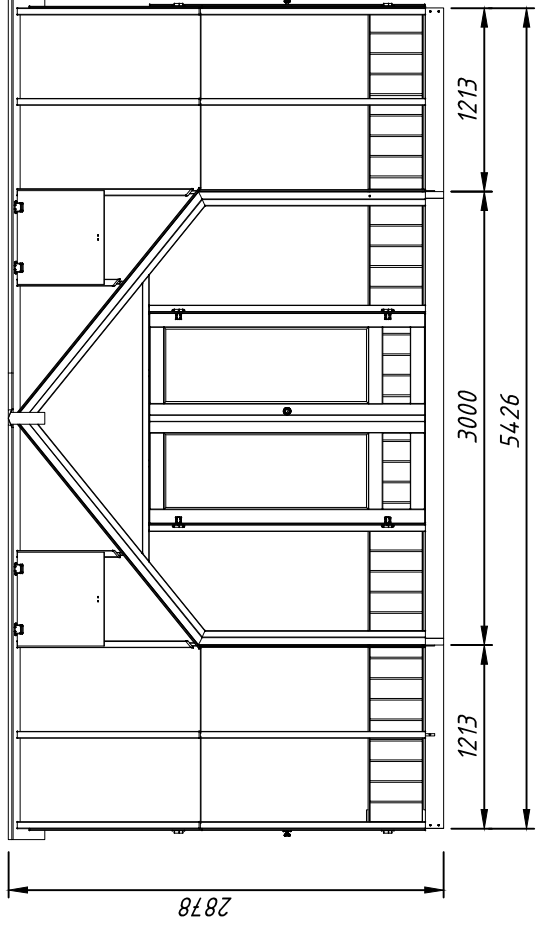
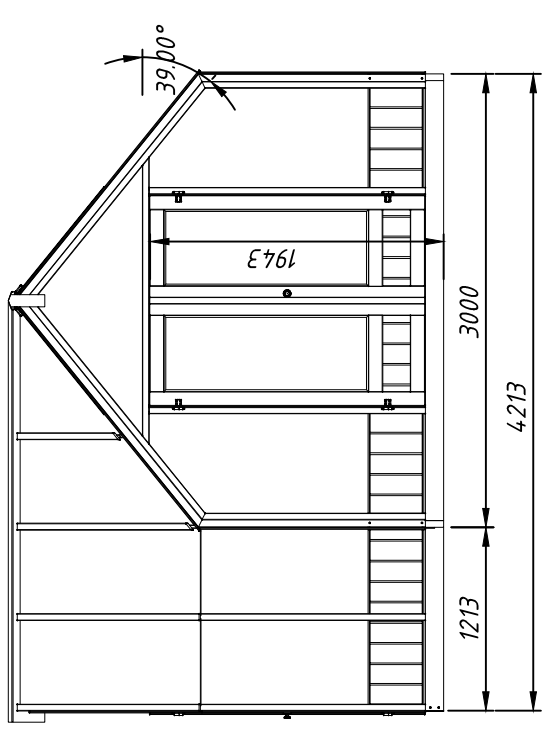

Scale 1:50
Paper A3
Page 1

Object name
EMILIA T-SHAPE

Drawing
Elevations, plan

AS Palmako
Näituse 25, Tartu, 50409, Estonia
tel. +372 73 55 530
fax. +372 73 55 544
www.palmako.com

Drawn by 007
Checked by
Approved by
Date 10.09.2021
Date
Date

- det 1 - 1 pc
- det 2 - 3 pcs
- det 3 - 2 pcs
- det 4 - 2 pcs
- det 42 - 1 pc
- F5 - 16 pcs
- F6 - 8 pcs

1

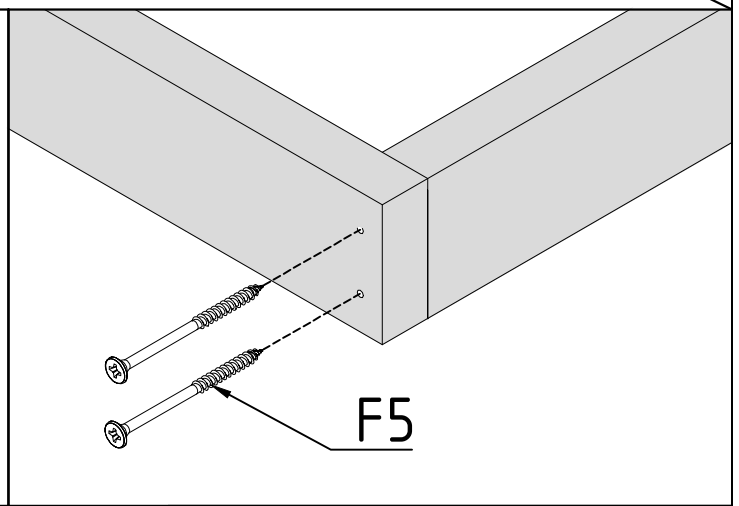
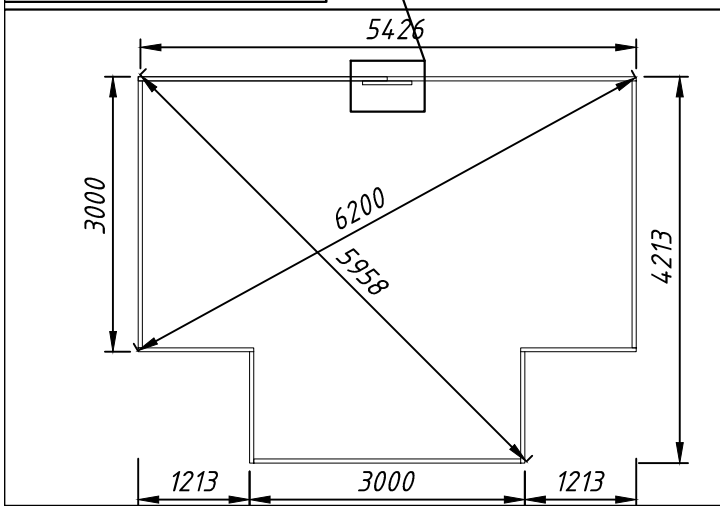
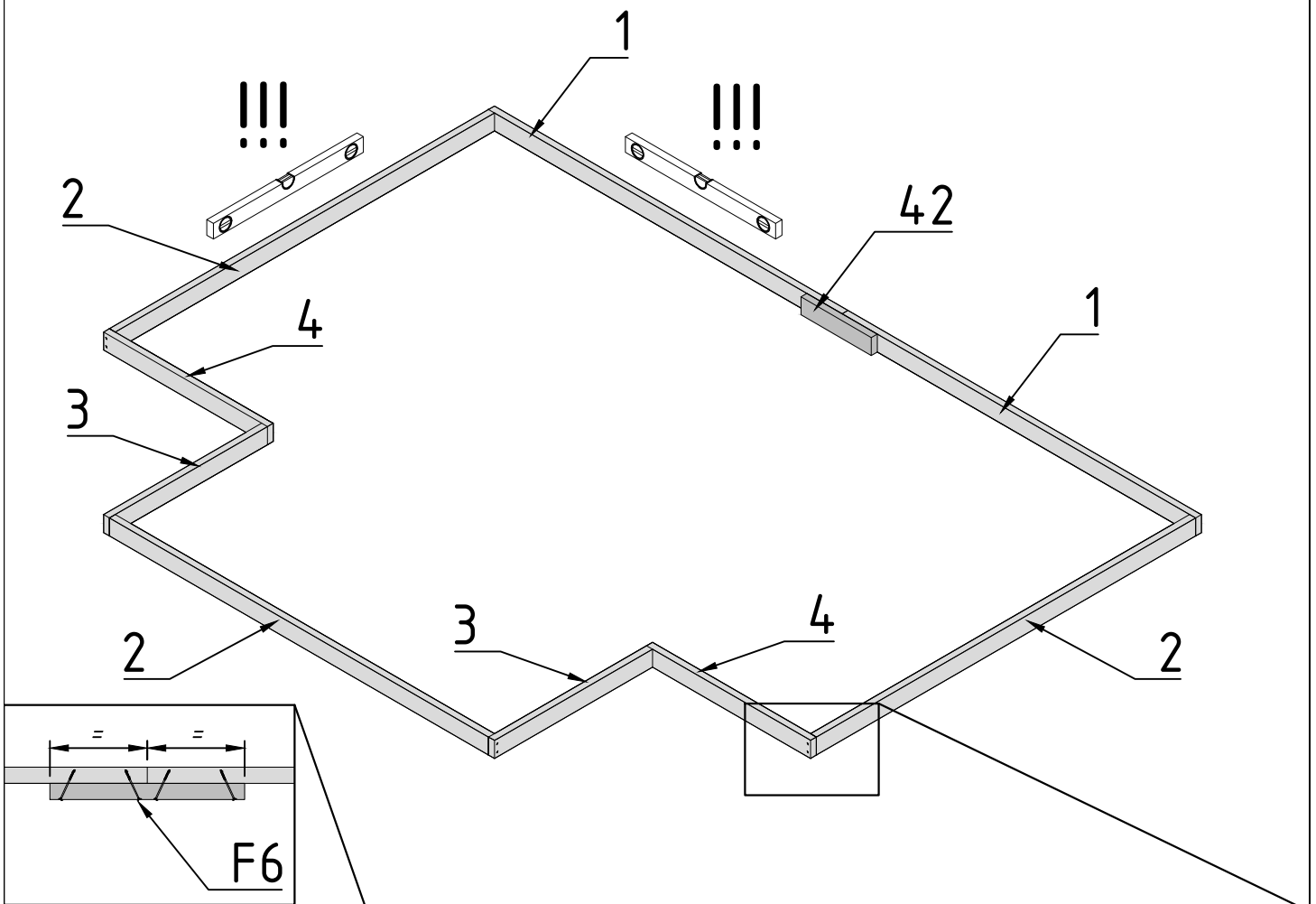

- EL 1 - 6 pcs
- EL 2 - 2 pcs
- EL 3 - 2 pcs
- EL 4 - 1 pcs
- EL 5 - 1 pcs
- F6 - 33 pcs

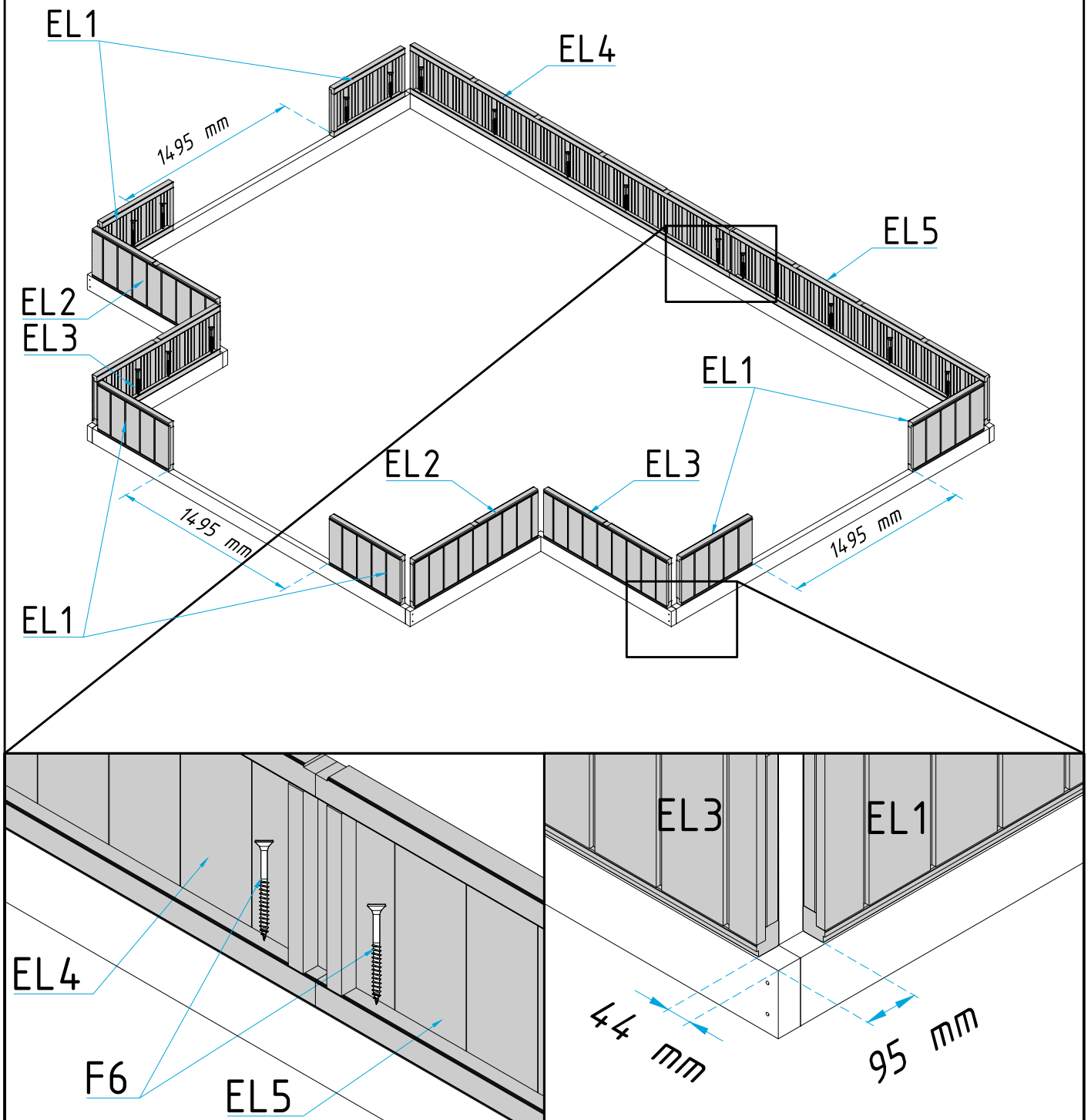

- det 5 - 1 pcs
- det 6 - 1 pcs
- det 7 - 3 pcs
- det 8 - 3 pcs
- det 13 - 3 pcs
- det 14 - 3 pcs
- det 26 - 6 pcs

- F6 - 24 pcs
- F7 - 72 pcs
- F29 - 8 pcs

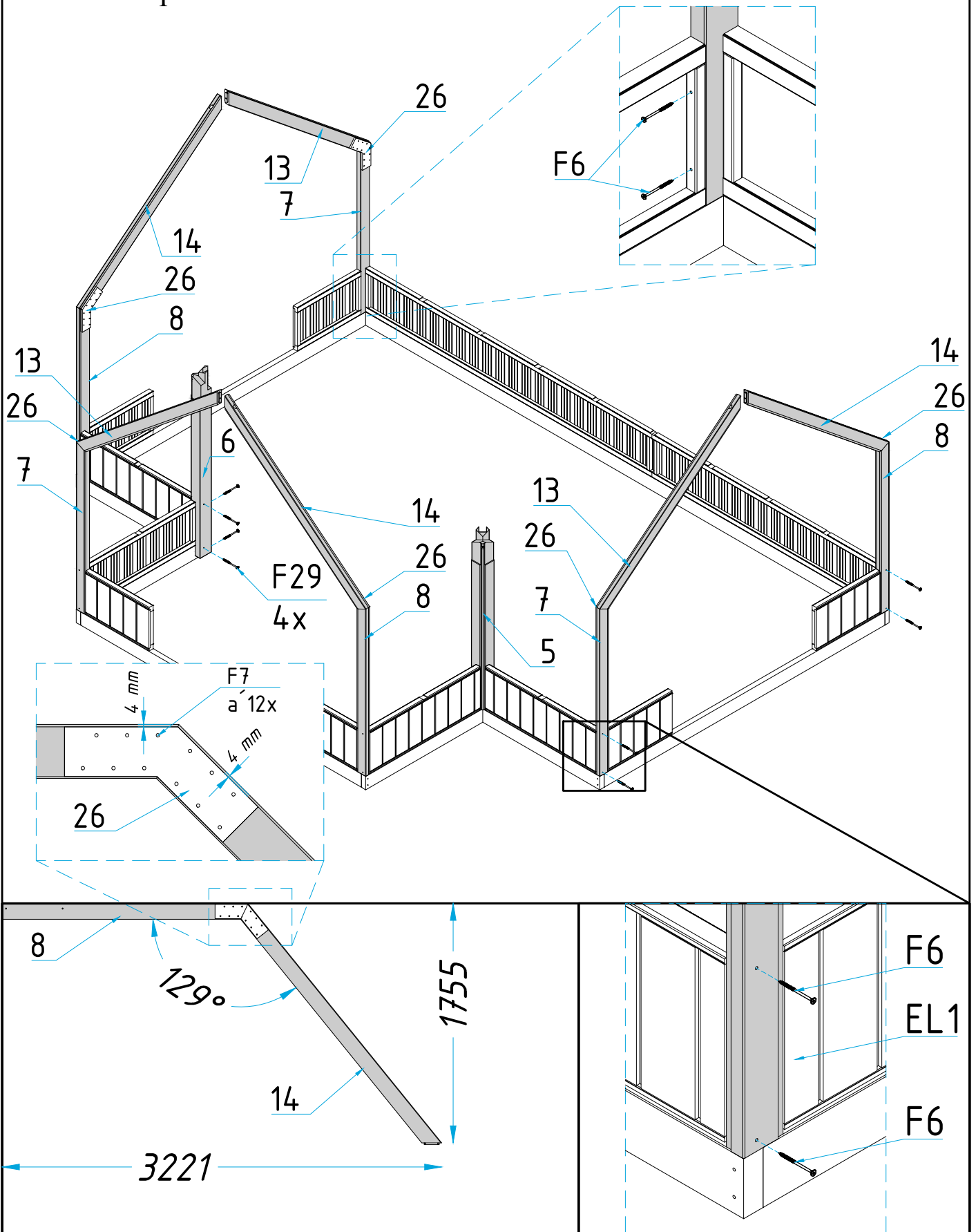

- det 9 - 3 pcs
- det 10 - 3 pcs
- det 11 - 3 pcs
- det 12 - 3 pcs
- F6 - 36 pcs

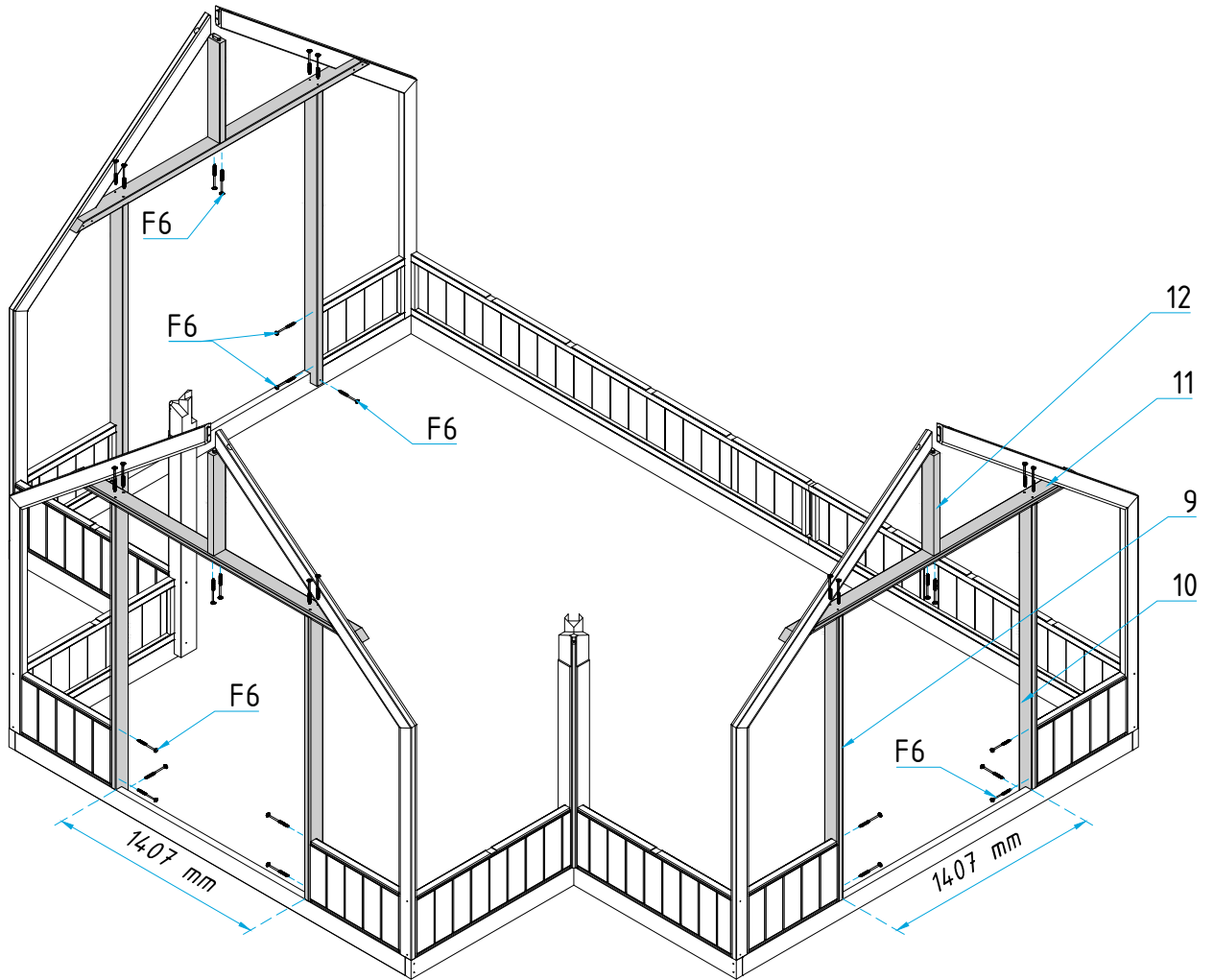

det 15 - 1 pcs
 det 16 - 1 pcs
 det 17 - 1 pcs
 det 18 - 1 pcs

F5 - 8 pcs
 F6 - 12 pcs
 F9 - 12 pcs
 F11 - 3 pcs
 F12 - 3 pcs
 F13 - 6 pcs
 F24 - 5 pcs
 F25 - 5 pcs
 F28 - 1 pcs

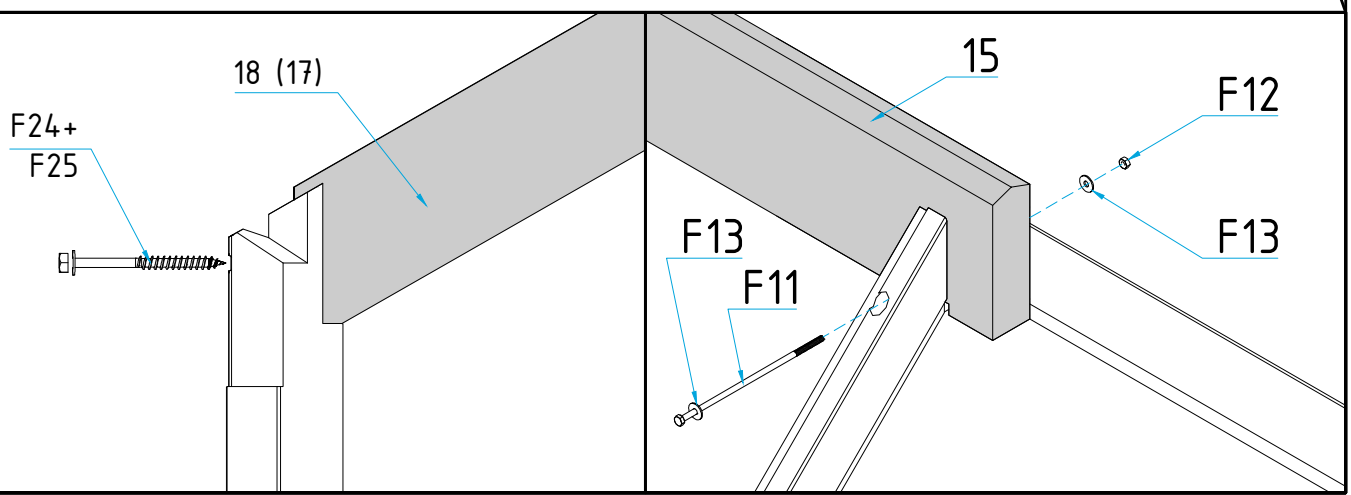
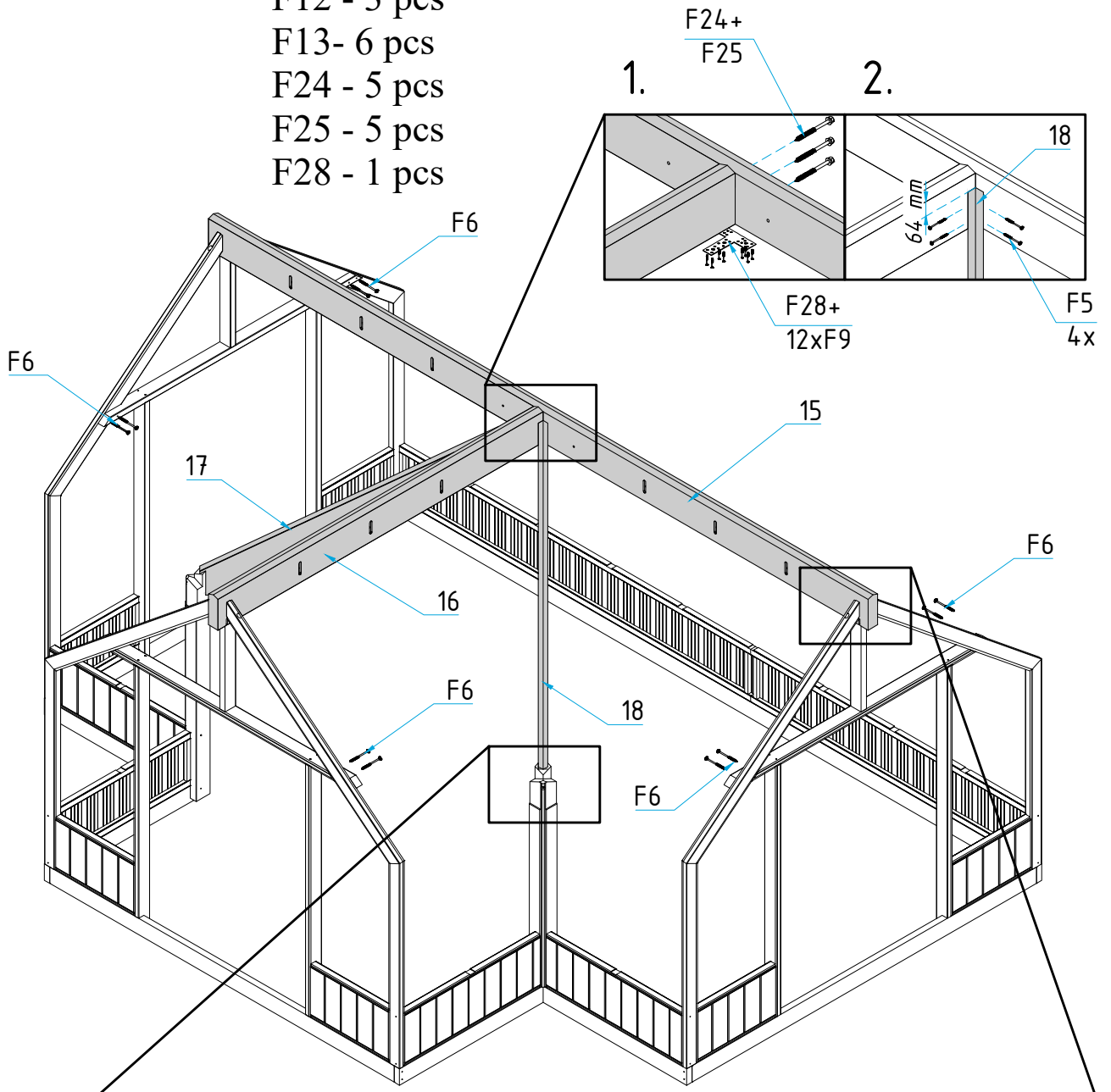

- | | |
|-----------------|--------------|
| det 19 - 12 pcs | F6 - 36 pcs |
| det 20 - 12 pcs | F7- 360 pcs |
| det 21 - 2 pcs | F11 - 9 pcs |
| det 22 - 2 pcs | F12 - 11 pcs |
| det 23 - 2 pcs | F13 - 22 pcs |
| det 24 - 2 pcs | F23 - 2 pcs |
| det 25 - 4 pcs | |
| det 26 - 20 pcs | |
| det 27 - 1 pcs | |
| det 28 - 6 pcs | |

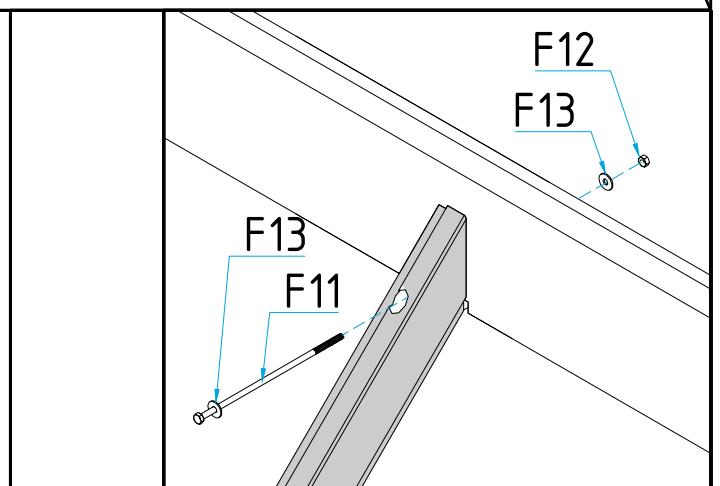
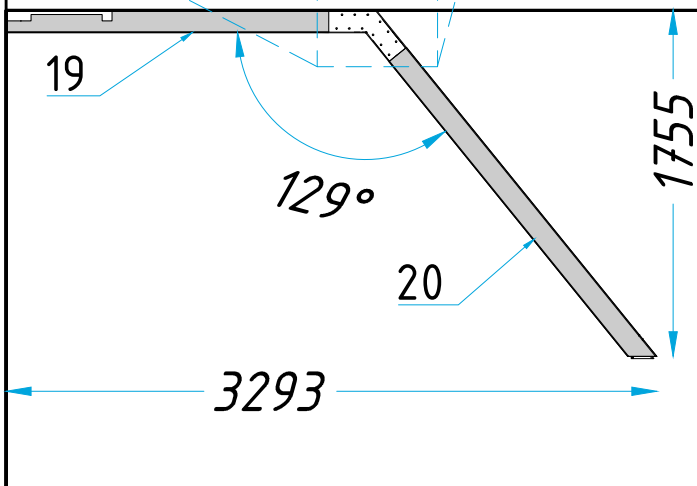
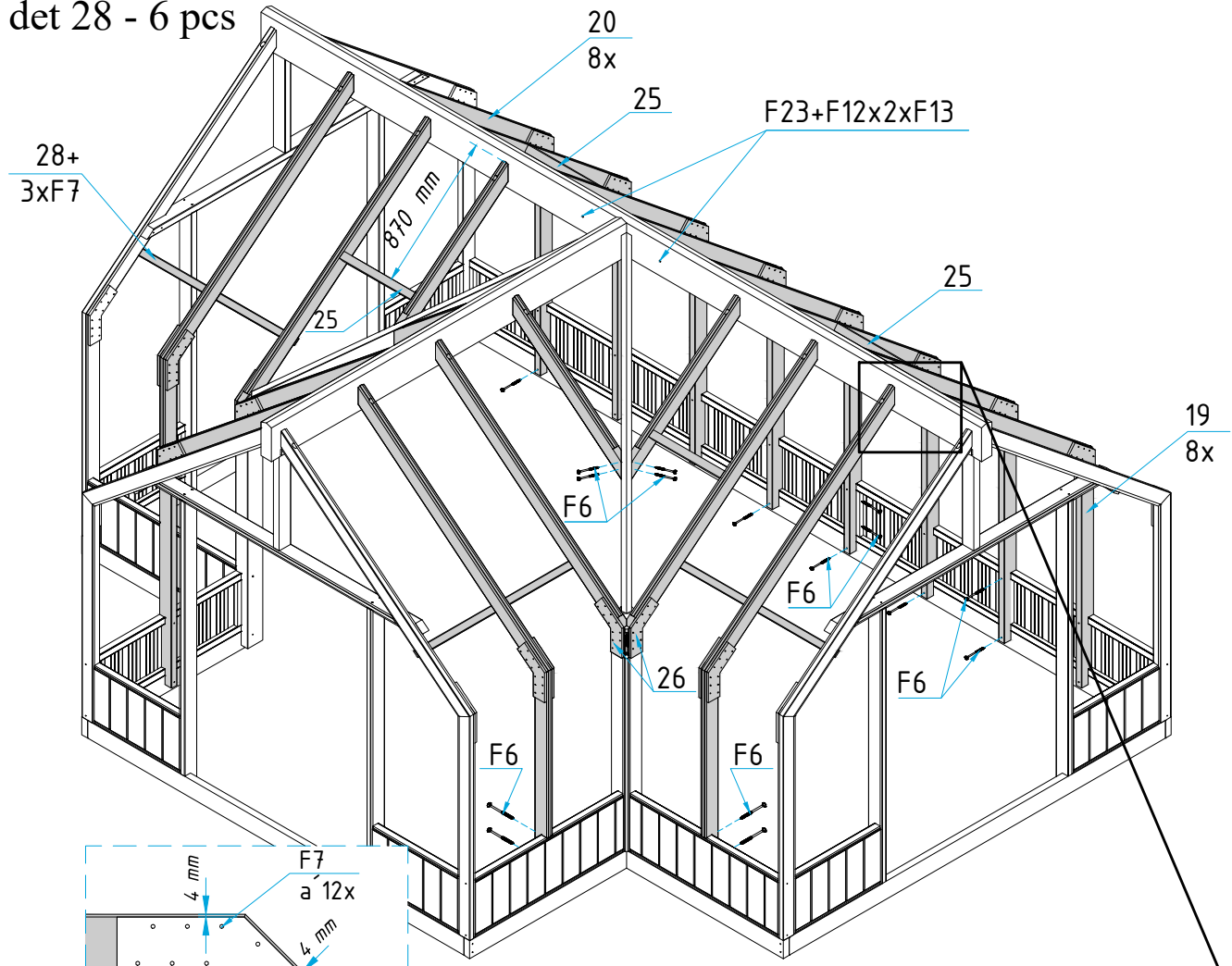

det 402 - 13 pcs
det 411 - 4 pcs
det 29 - 18 pcs
det 41 - 2 pcs

F3 - 18 pcs
F8 - 100 pcs
F20 - 18 pcs
F26 - 2 pcs
F30 - 8 pcs

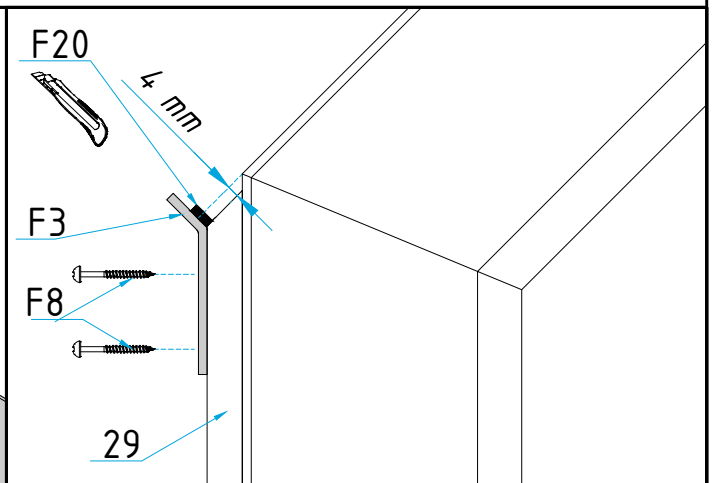
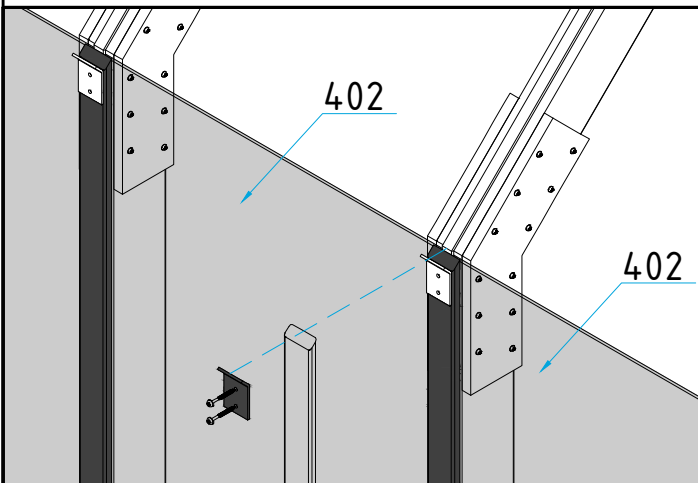
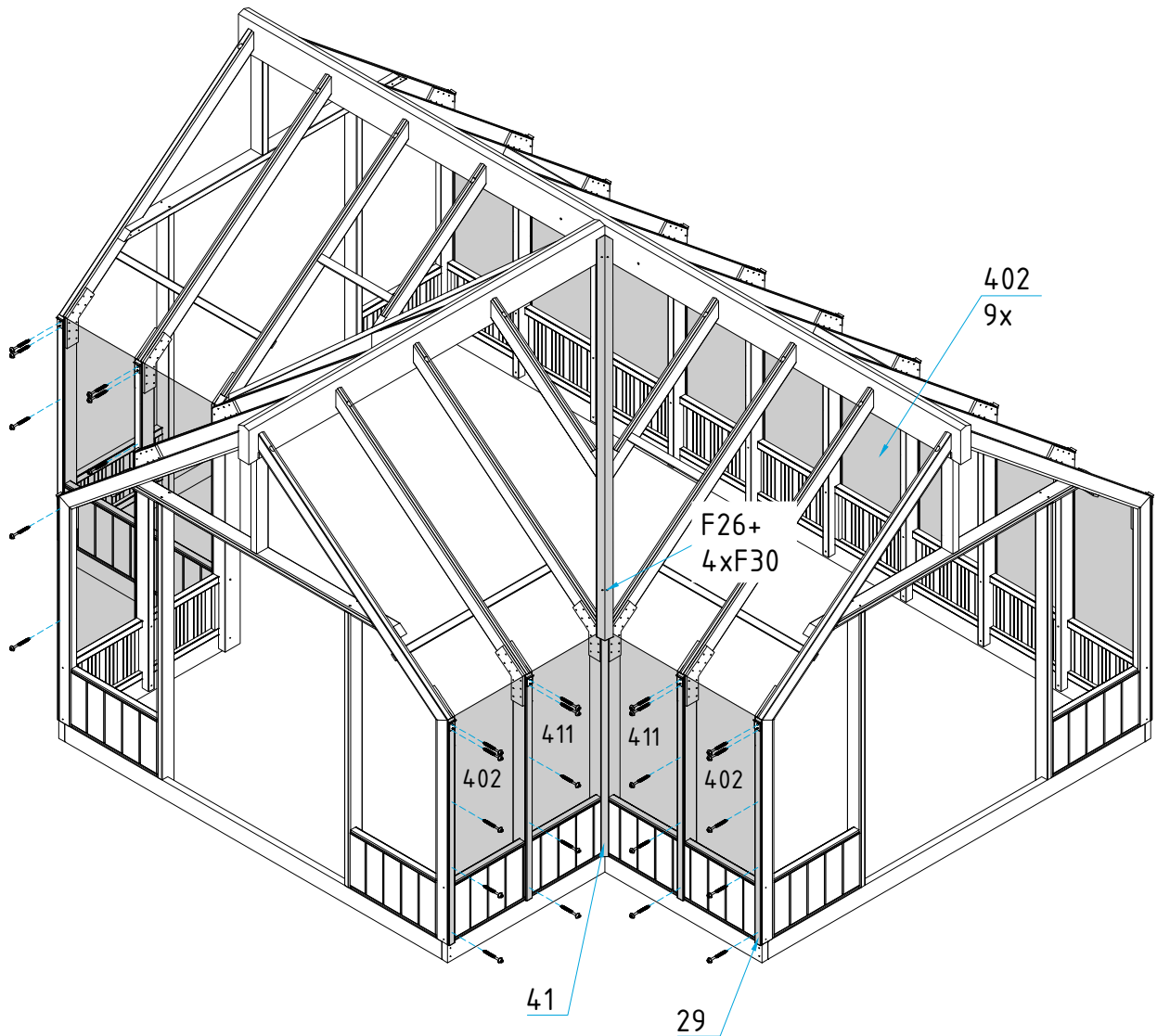

det 406 - 2 pcs
det 408 - 4 pcs
det 409 - 2 pcs
det 31 - 2 pcs
det 32 - 2 pcs
det 33 - 2 pcs
det 34 - 2 pcs

F8- 24 pcs

8

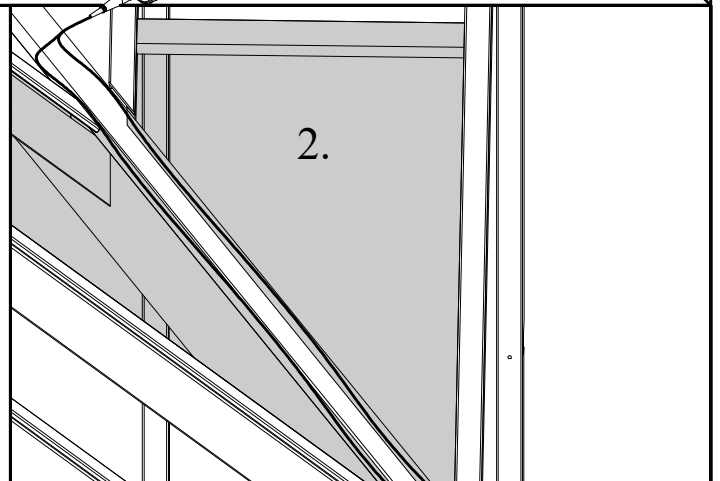
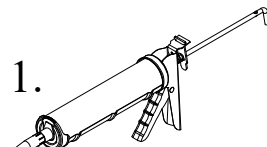
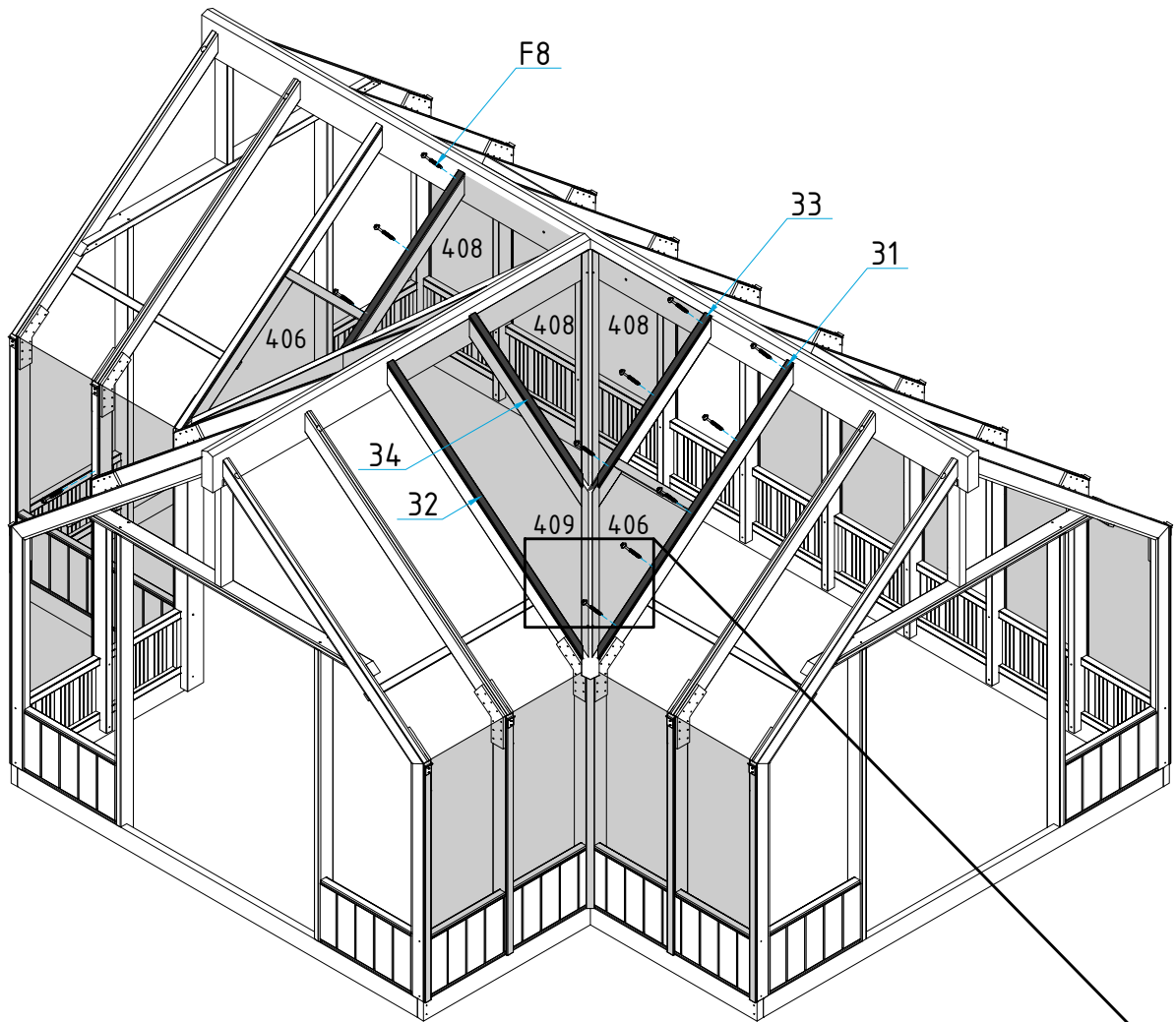

F2

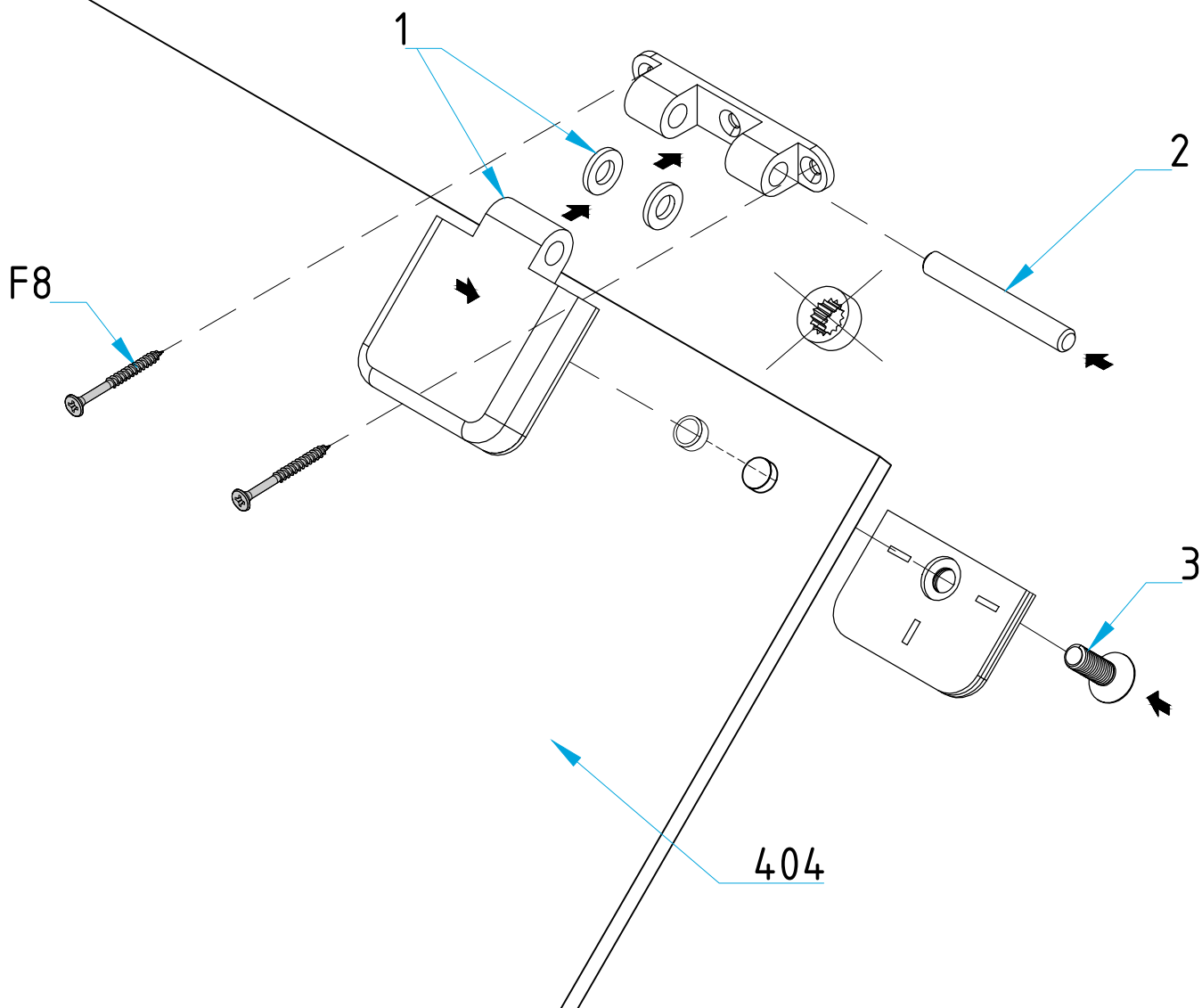

det 401 - 11 pcs
 det 403 - 2 pcs
 det 404 - 4 pcs
 det 30 - 18 pcs
 F8 - 128 pcs

F1 - 4 pcs
 F2 - 8 pcs
 F14 - 3 pcs
 F15 - 1 pcs

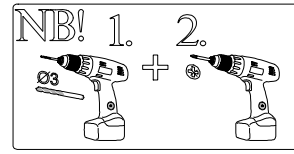

9-2

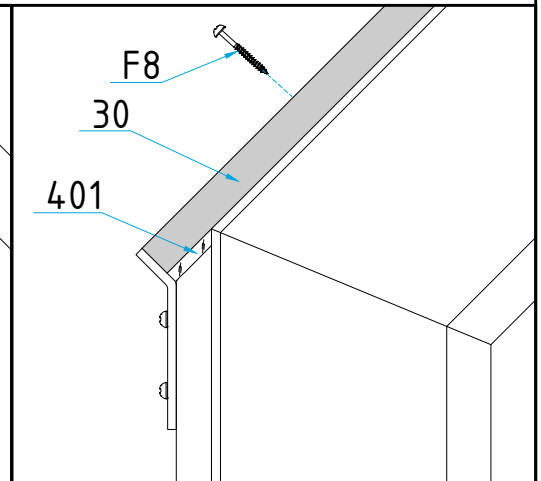
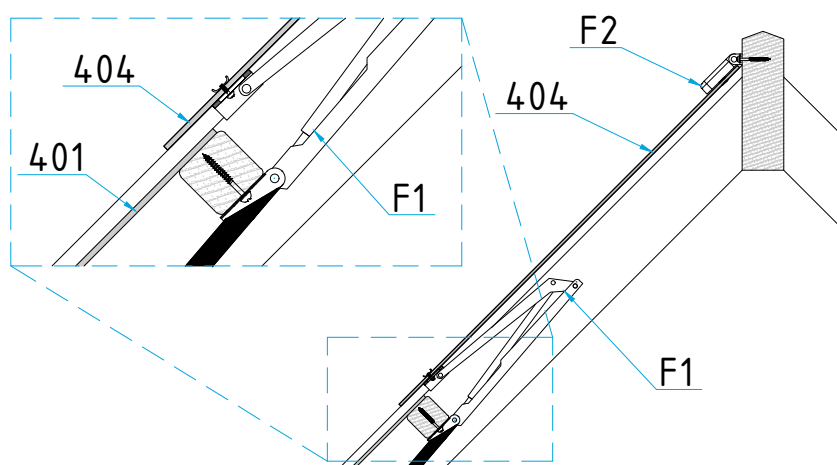
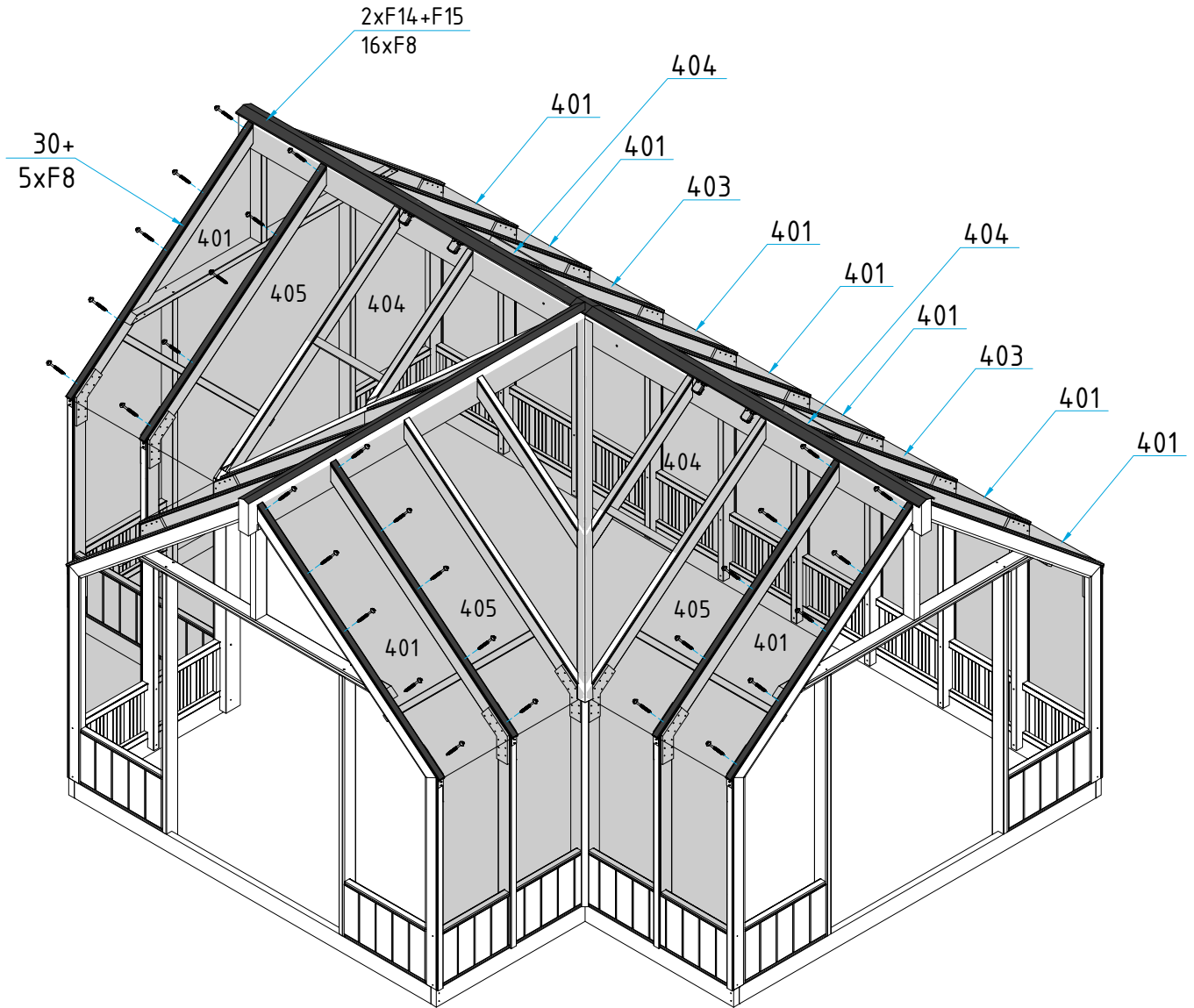

- det 407 - 3 pcs
- det 412 - 6 pcs
- det 35 - 3 pcs
- det 37 - 12 pcs
- det 38 - 6 pcs
- det 39 - 6 pcs
- det 40 - 6 pcs
- F8 - 165 pcs

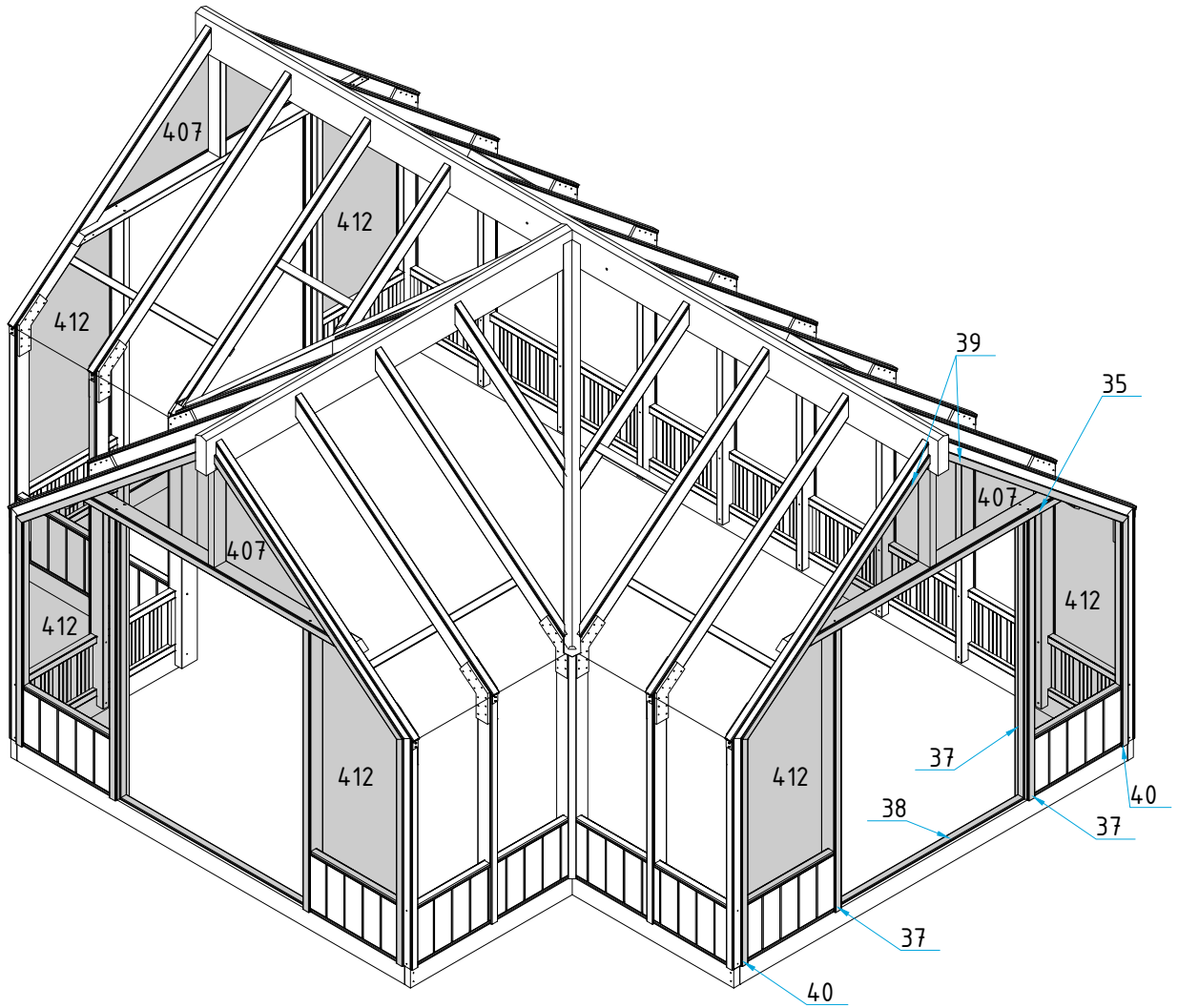
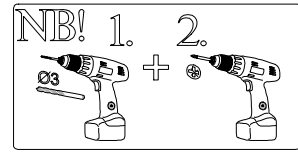

KUL-145 - 3 pcs
KUL-145-2 - 3 pcs

F4 - 12 pcs
F9 - 24 pcs
F10 - 52 pcs
F16 - 6 pcs
F17 - 3 pcs
F18 - 3 pcs
F19 - 3 pcs
F21 - 6 pcs
F22 - 48 pcs

